

form
of
industrial design



Kunde

dolphin e-bikes GmbH, Schweiz

Aufgaben

- Projektmanagement
- Produktdesign
- Konstruktion
- Prototypenkontrolle
- Messepräsentation
- Grafikdesign



Produkt-Flyer
Grafik
DTP

Messepräsentation
Prototyp

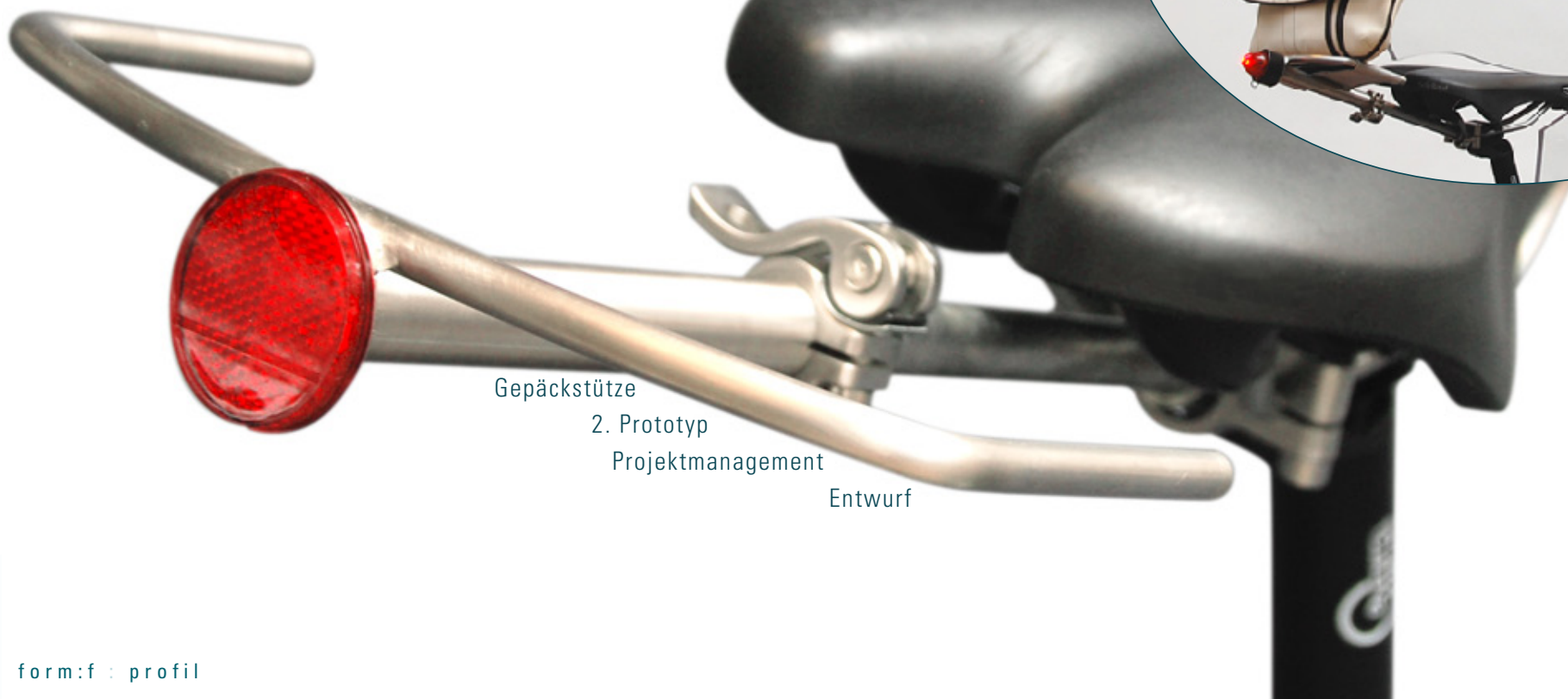

Gepäckstütze

2. Prototyp

Projektmanagement

Entwurf

Anfrage

Follow Me, Family Cycling GmbH

Aufgaben

Designstudie
Ergonomie



Einkaufsanhänger
Tiefziehwurf

Chassi
Kundendatengrundlage

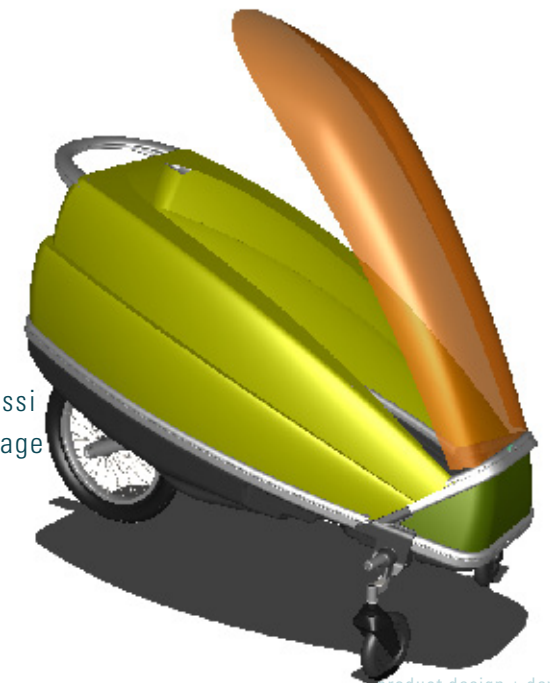

Kunde Klever Mobility Co. Ltd., Taiwan

Aufgaben Zielgruppenrecherche
Produktdesign



Entwurf
Rendering

Kundin INHOUSE

Aufgaben Produktdesign

Konstruktion
Visualisierung
Entwicklung
Kostenkalkulation
Möbelbau

Möbelbau

Visualisierung



Kunde Gepida Bicycle Ltd., Ungarn

- Aufgaben**
- Projektmanagement
 - Produktdesign
 - Konstruktion
 - 3D-Modeling
 - Modellbau
 - Prototypenkontrolle
 - Produktplanung
 - Beratung

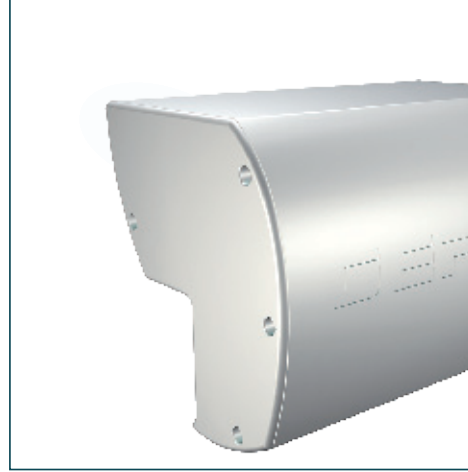

3D-Modeling

SLA-Daten

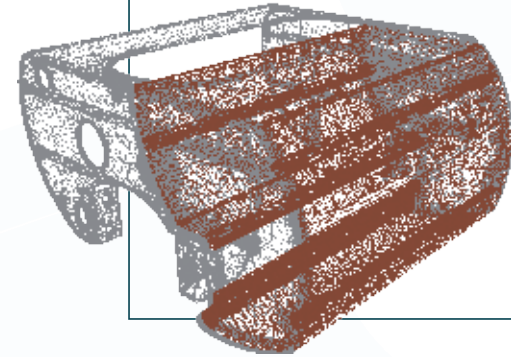

2. Prototyp



form:f : profil

Gepäckträger
Produkt
Design
Konstruktion

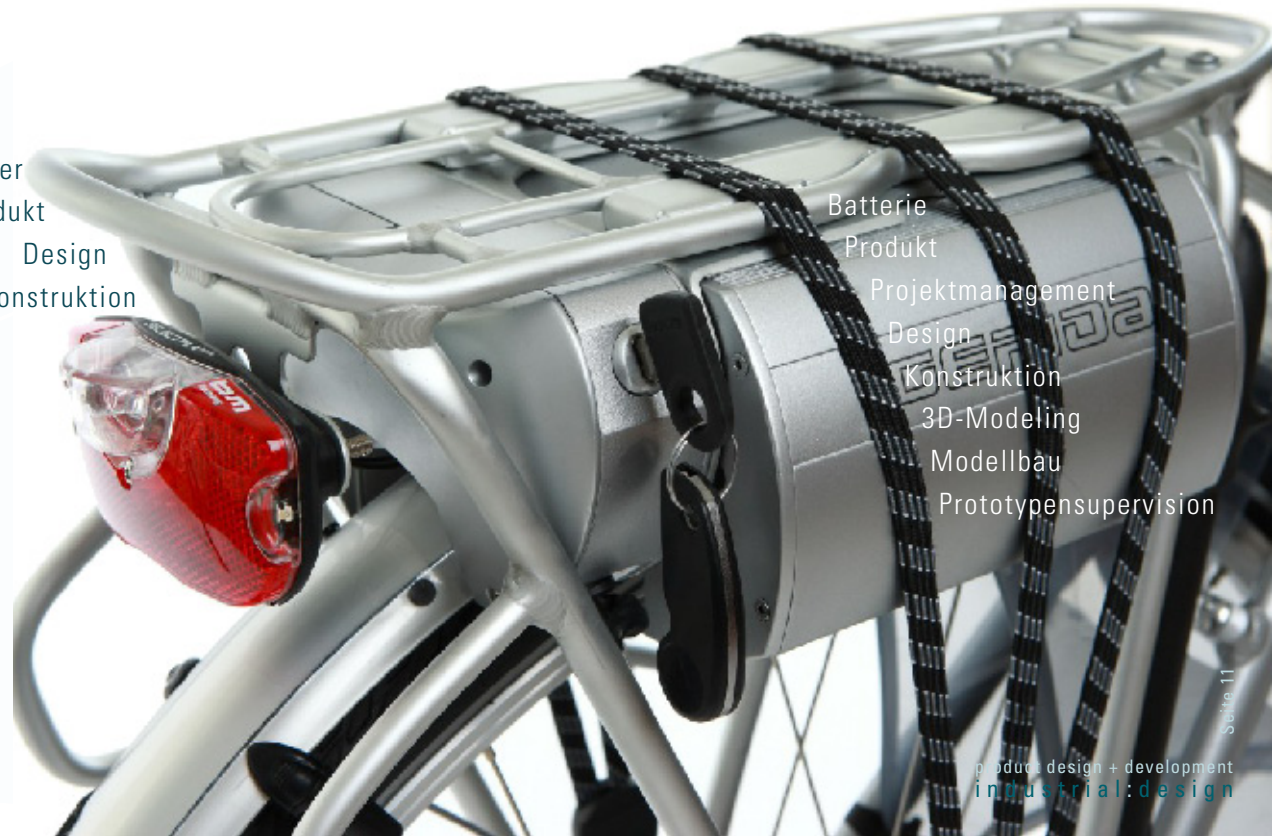

Batterie
Produkt
Projektmanagement
Design
Konstruktion
3D-Modeling
Modellbau
Prototypensupervision

Kunde

Gepida Bicycle Ltd., Ungarn

Aufgaben

- Produktdesign
- 3D-Modeling
- Beratung
- Grafikdesign
- Interfacedesign

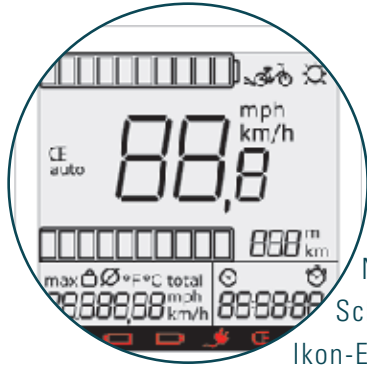

Interface
Navigationskonzept
Schriftentwicklung
Ikon-Entwicklung



Display
Design
Konzeption



Motor
Restyling

Kunde

STL Technology Co. Ltd., Taiwan

Aufgaben

- Produktdesign
- Basiskonstruktion
- Entwicklungsberatung



Entwurf 01



Entwurf 02

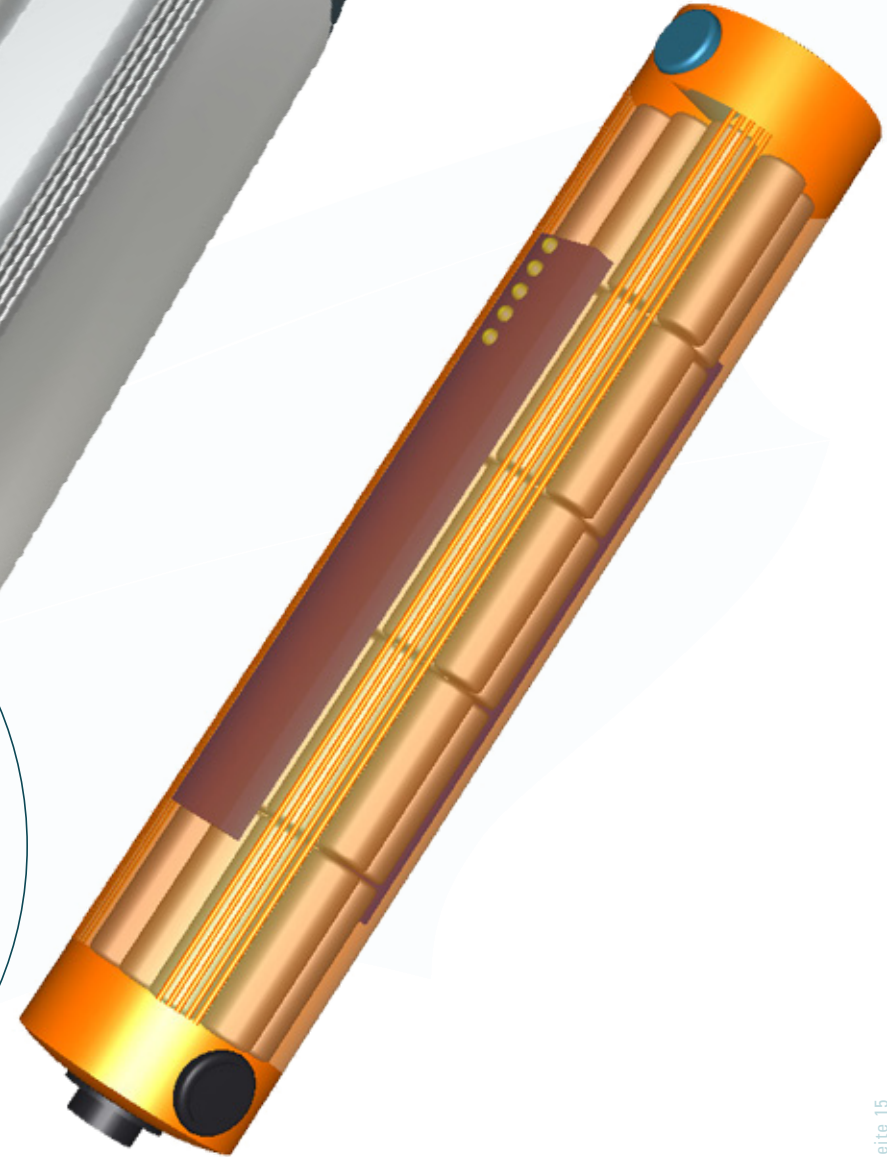

Entwurf 03



Produkt

Kunde STL Technology Co. Ltd., Taiwan

Aufgaben
Produktdesign
Basiskonstruktion
Entwicklungsberatung

Display
Prototyp



Entwurf 01

Entwurf 02

3D-Daten

Kunde

LA E-Ride Co. Ltd., Thailand

Aufgaben

Produktdesign
Komponentenberatung

Batterie
Entwurf 01



Gepäckträger
Entwurf



Gepäckträger
Prototyp

Display
Entwurf

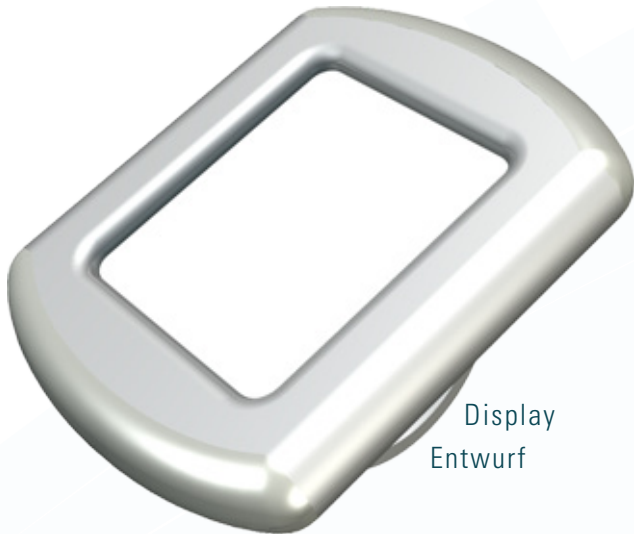

Batterie
Entwurf 02

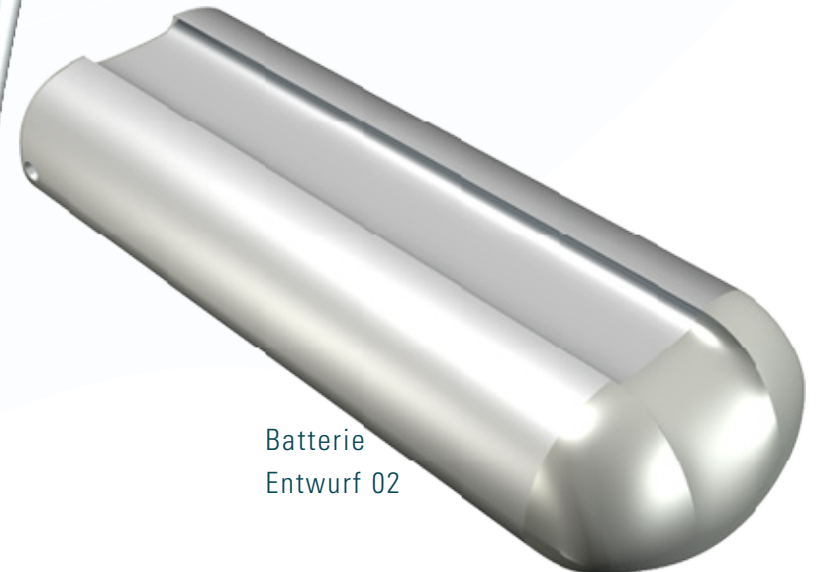

Anfrage Donauer Solartechnik Vertriebs GmbH

Aufgaben Designstudie
Projektplanung

Renderings

Material	Unit	Quantity	Price	Material Price	Material Price	Material Price	Material Price
...

Kosten-Kalkulation

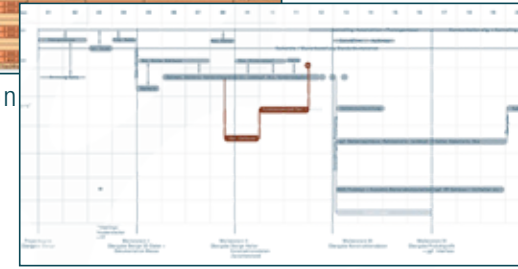

Zeit+Team-Planung



Offroad-E-Bike
Entwurf



City-E-Bike
Entwurf



Damen-E-Bike
Entwurf

Anfrage Hawk Bikes e+m GmbH, Berlin

Aufgaben Produktdesignstudie



Entwurf 01 + 02

Rendering



Kunde clever drives GmbH, Schweiz

Aufgaben Produktdesign
Präsentations-Renderings

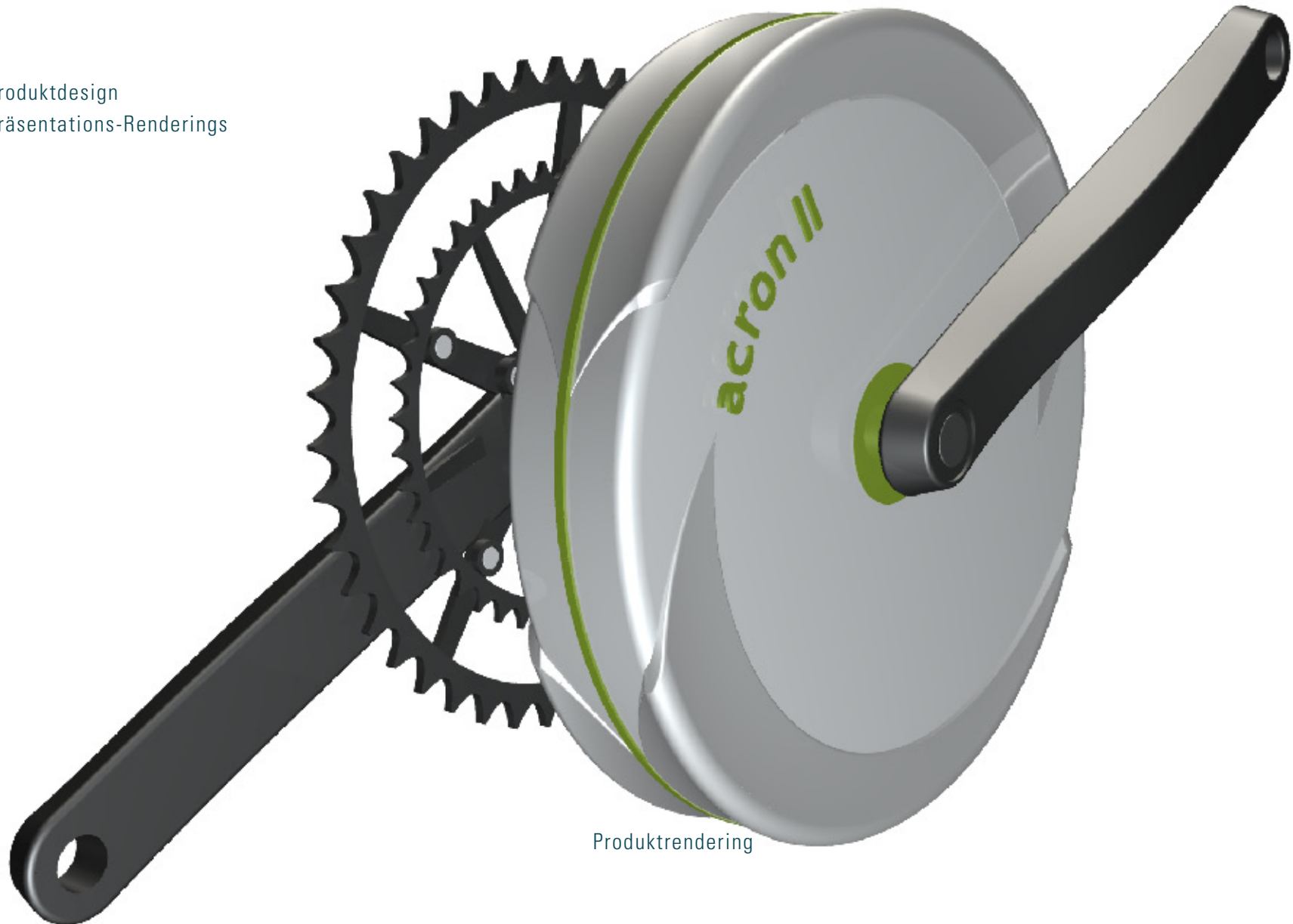

Produktrendering

Kunde emco electroroller GmbH, Lingen

Aufgaben
Produktdesign
Konstruktion
Entwicklungsberatung
Grafikdesign

E-Ladesäule
Produkt
Entwurf
Konstruktion

Innenteil
Produkt
Konstruktion

Produktgrafik
Entwurf



Kunde Park&Charge, Schweiz

Aufgaben
Basisentwurf
Produktdesign
Grafikdesign
Corporate-Beratung



Entwurf 02

form:f : profil



Entwurf 03

Logo
Entwurf + DTP



Entwurf 01

Kunde Ultra Motor Ltd., Großbritannien

Aufgaben Projektmanagement
Produktdesign
Modellbaukontrolle
Interfacedesign

Entwurf

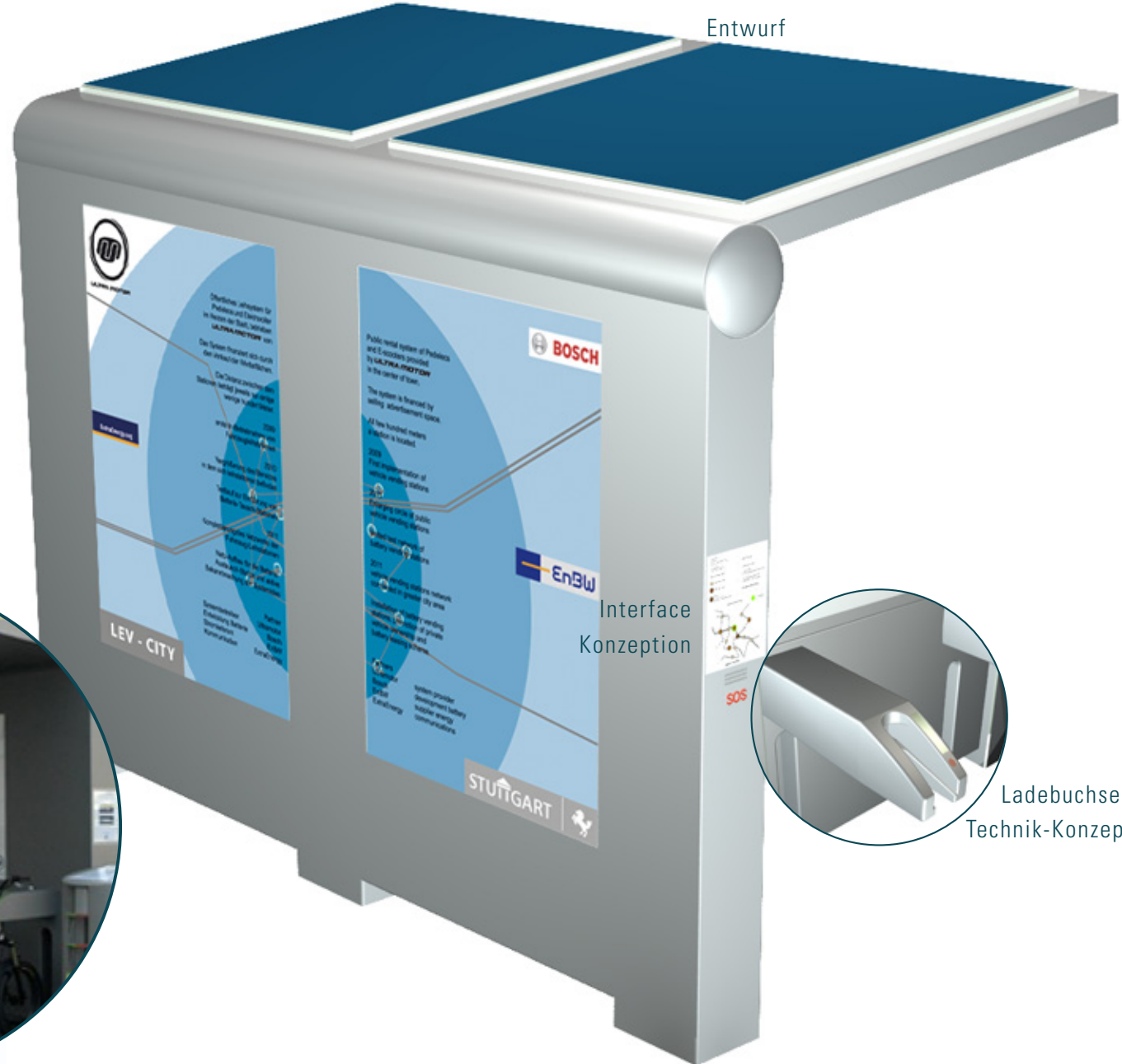

Interface
Konzeption

Ladebuchse + Schloss
Technik-Konzeption



1:1 Modell

Kunde ExtraEnergy e.V., Tanna

Aufgaben Projektmanagement
Produktdesign
Modellbaukontrolle
Interfacedesign

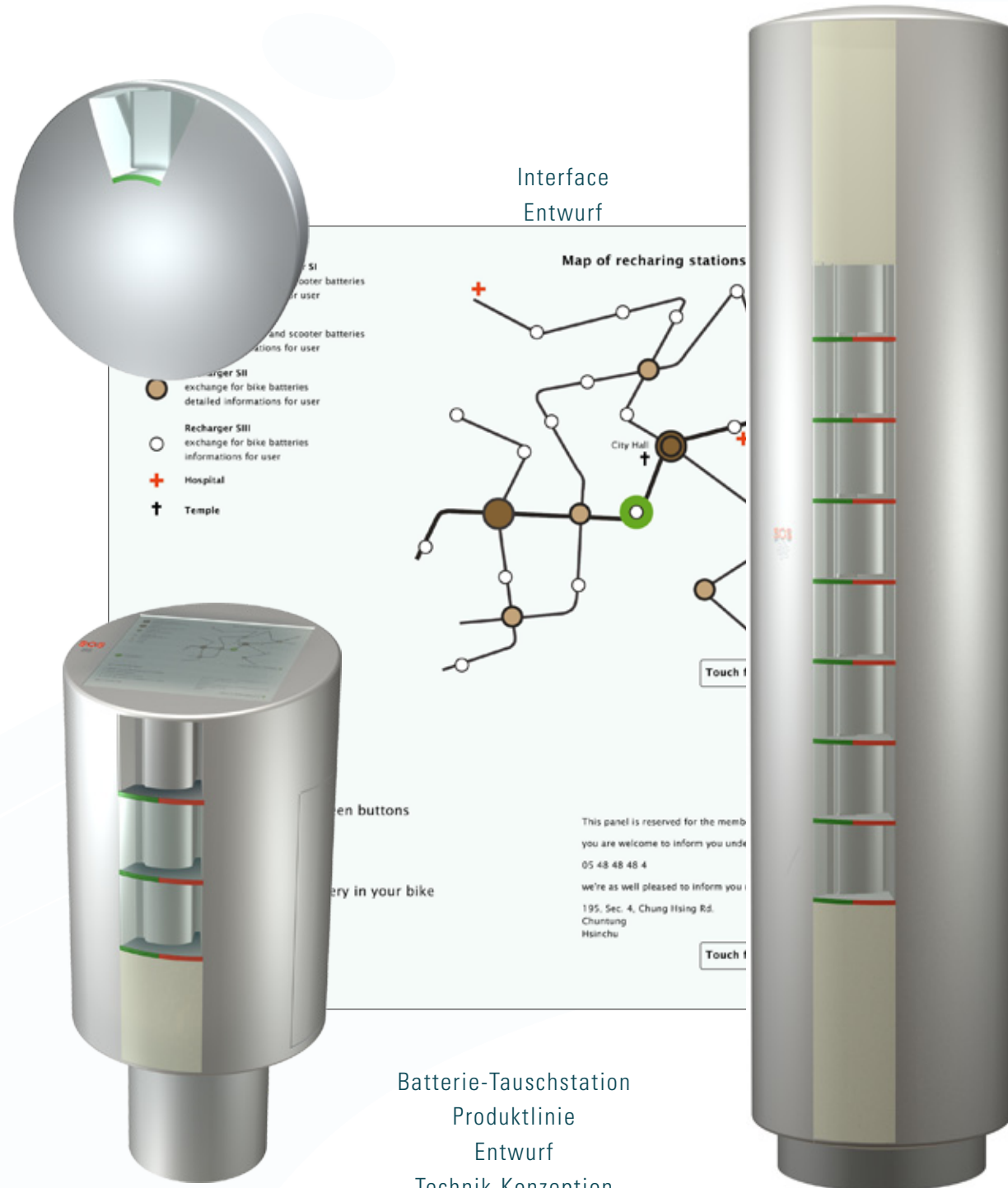

Mock Up



Kunde frei

- Aufgaben
- Projektmanagement
 - Produktdesign
 - Konstruktion
 - Modellbau
 - Prototypenbau
 - Grafikdesign
 - DTP
 - Marketing
 - Messekonzeption
 - Produktplanung



fiera milano



multifunktionale Boxen
1. Prototypen



modulares
Falthängeregale
1. Prototyp

Faltkleiderschrank
1. Prototyp

Postkarten
Grafik
DTP

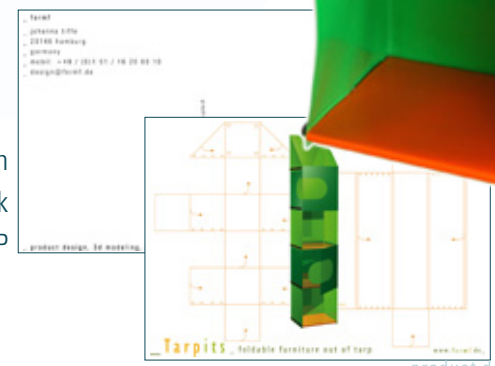

Kunde eigenes Projekt

Aufgaben
Projektmanagement
Produktdesign
Konstruktion
Modellbau
Prototypenbau
Grafikdesign
Marketing
Messekonzeption

Publikation
2007
Mailänder Möbelsalon
Italien

Klettwand



Hausschuhe

multifunktionale
Tasche



Schlüsselanhänger
Fahrradband

Klettwand



Kunde RP Studio, Italien

Aufgaben Ideenfindung
Entwurf Möbellinien



Produkt

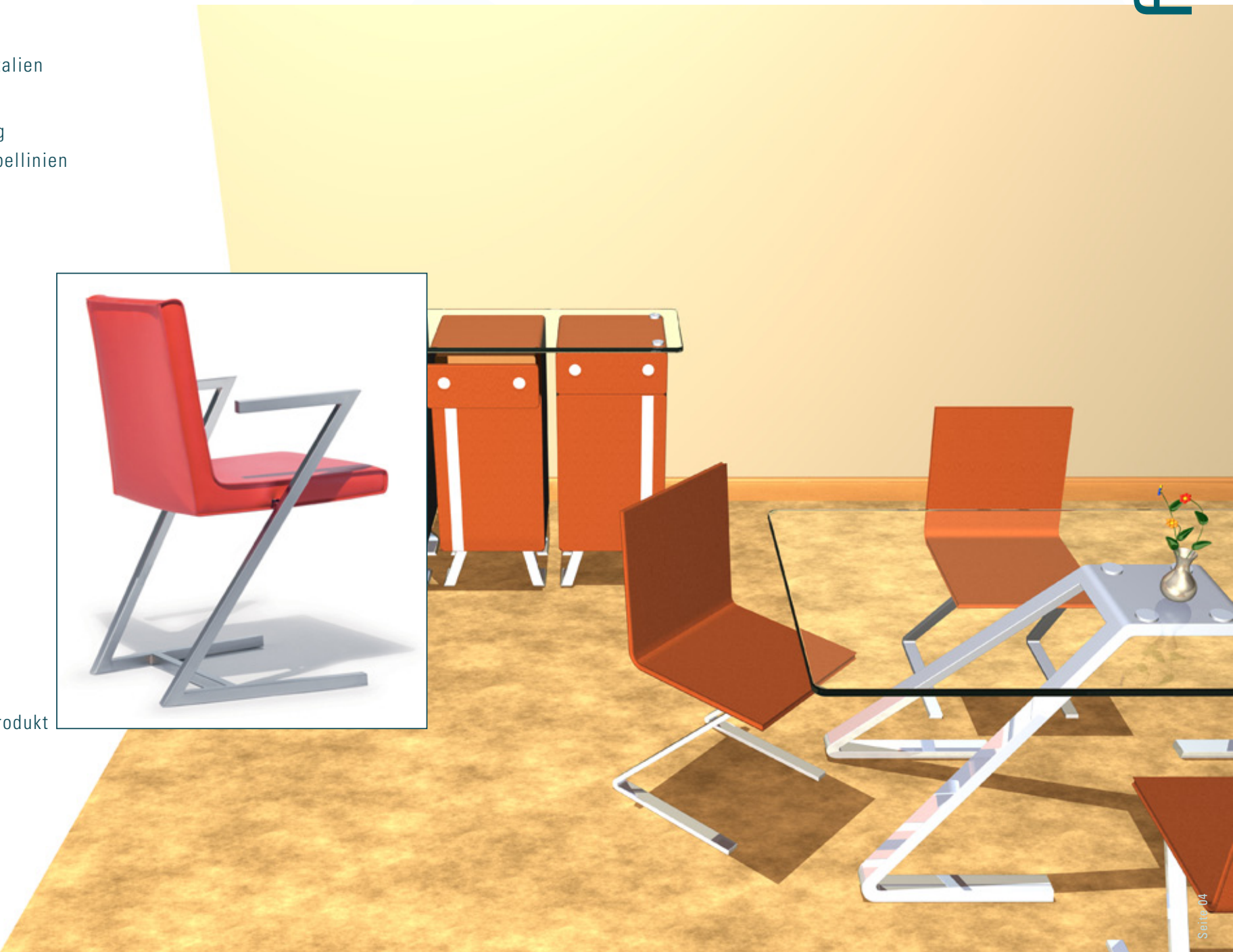

Rendering

Kunde Jahn Design, Deutschland

Aufgaben Produktdesign
Konstruktion Solidworks

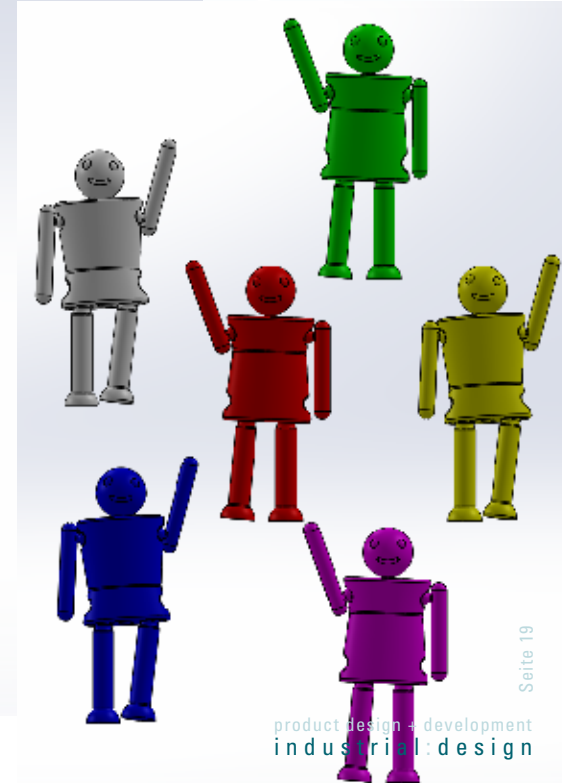
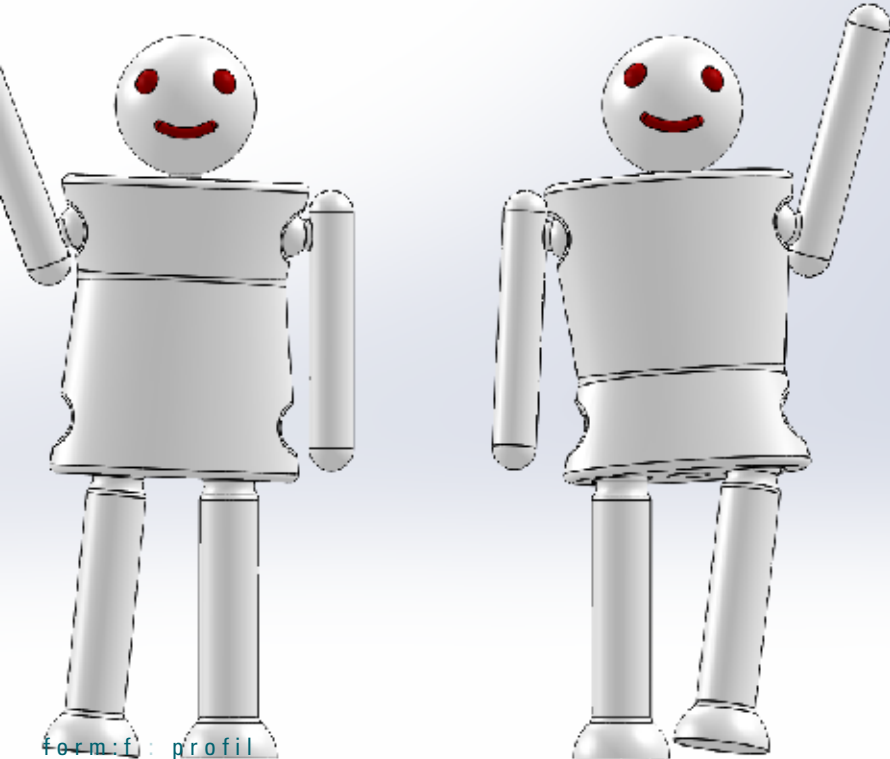
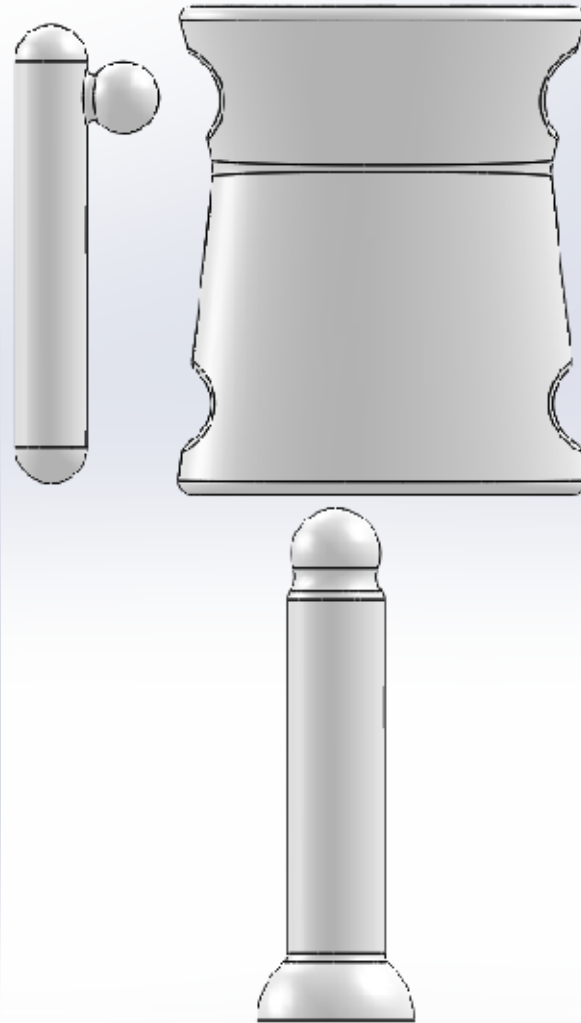

6 Bauteile = 2 Figurenvarianten

Kunde STS SpA, Italien

Aufgaben Modeling

Publikation 2006

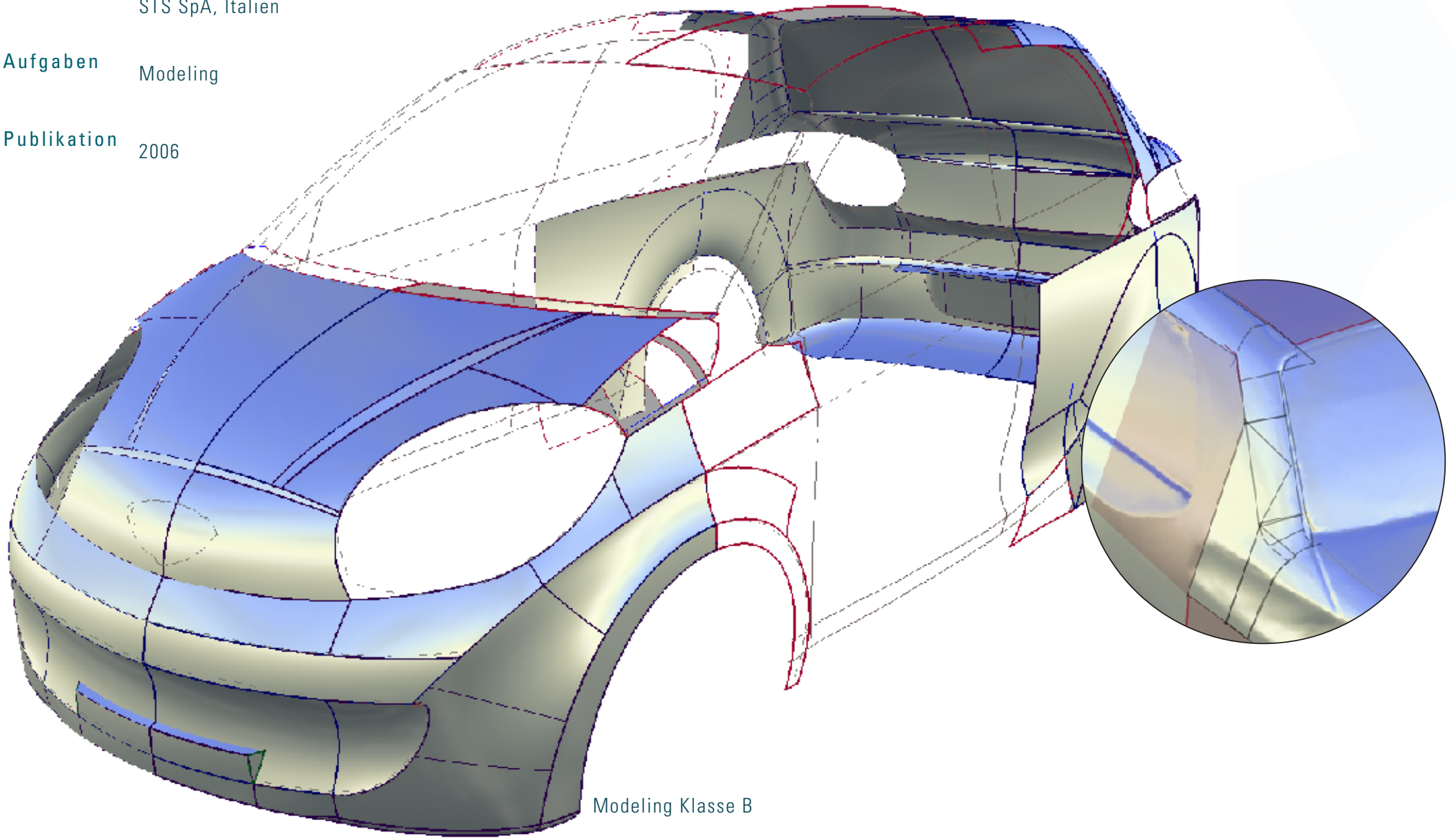

Modeling Klasse B

Kunde Mac Design S.a.s., Italien

Aufgaben Ideenfindung
Entwurf

Publikation 2005

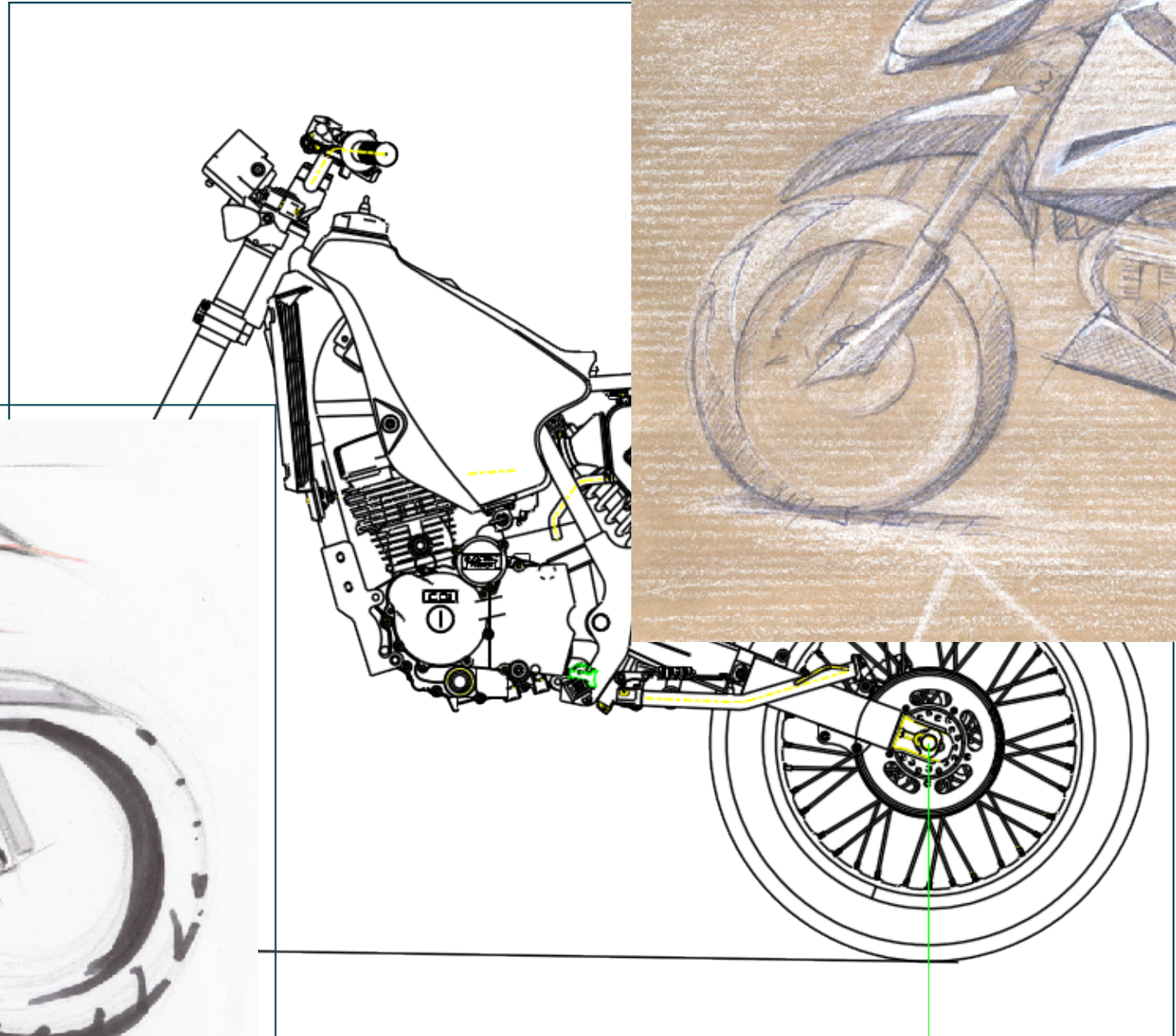
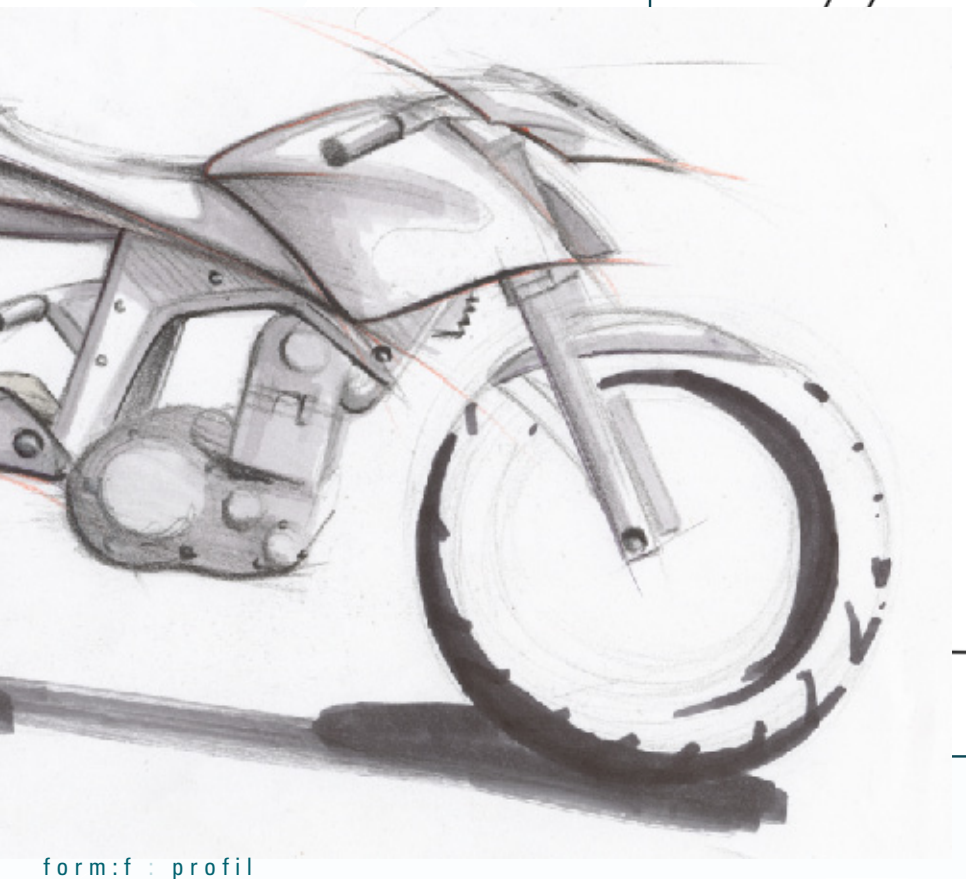

Handentwurf

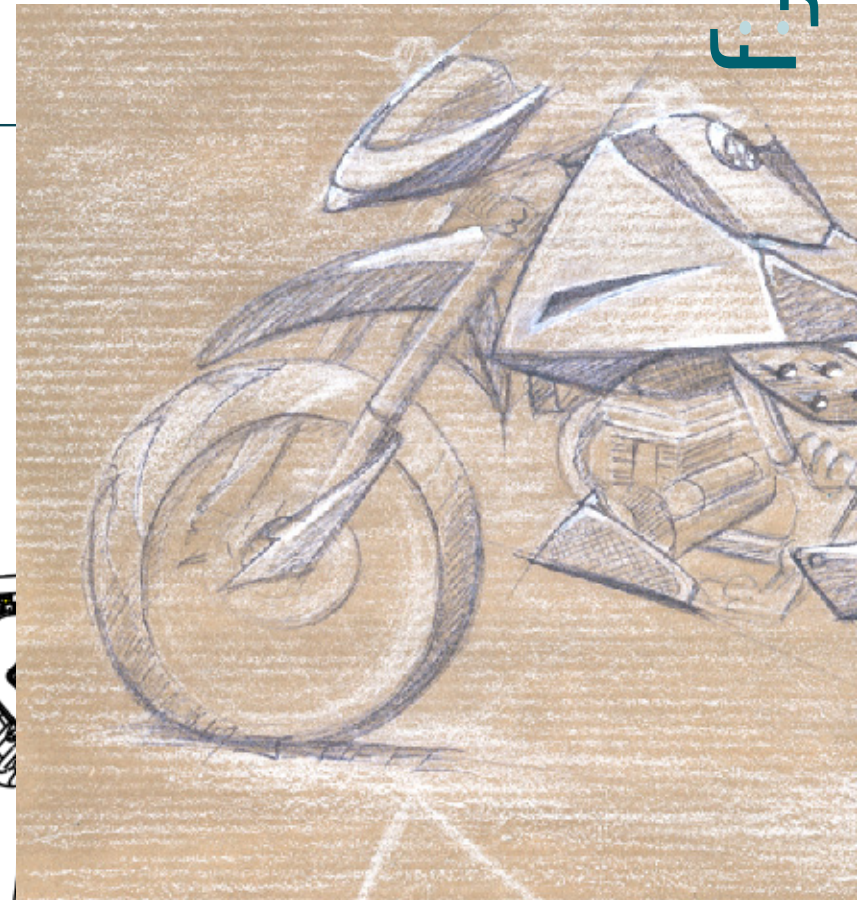

Handentwurf

Support MV Agusta S.p.A., Italien

Arbeiten Projektmanagement
Komponentenrecherche
Produktdesign
technische Konzeption
Modellbau
Grafikdesign
Produktvisualisierung
Modeling

Publikation 2004
Intermot, München

Preise 2003
Stipendium
DAAD



Modeling Klasse B



Handentwurf

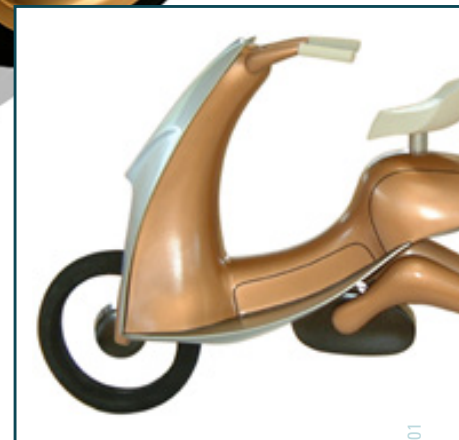

1:5 Modell

Seite 01